



KAESER Blowers

Low Pressure Solutions

With the world-renowned SIGMA or OMEGA rotor profile

Flow rate 0.59 to 160 m³/min

Pressure differential: Pressure up to 1100 mbar, Vacuum to 550 mbar

KAESER Blowers

The world-renowned compressor and blower manufacturer

Established by Carl Kaeser Sr. as a machine workshop in 1919, KAESER started on the road to becoming one of the world's leading compressed air systems providers when the first reciprocating compressor left the Coburg production line in 1948. The final breakthrough came in the 1970s with the development of the rotary screw compressor featuring the energy-saving SIGMA PROFILE.



Gera plant

In 1991, KAESER acquired the 'Geraer Kompressorenwerke', a company with a proud heritage of over 100 years of compressor and blower construction. Production of KAESER's newly developed OMEGA rotary blowers began at the plant in 1993 and today these highly efficient systems are exported, together with all necessary accessories and equipment, to every corner of the planet. Cov-

ering an area of over 60,000 m², the Gera plant currently employs approximately 300 people and produces KAESER's extensive range of rotary blowers, screw blowers and compressed air refrigeration dryers. All companies in the international KAESER group are linked by the very latest information and network technology.

Contents

How a KAESER rotary blower works.....	04
How a KAESER screw blower works.....	05
Screw blowers with the SIGMA PROFILE	06-07
EBS - FBS series, SFC/STC version: Dependable and efficient	08-09
Rotary blowers with the OMEGA PROFILE	10-11
BB - HB series, OFC/STC version: Complete blower systems	12-13
Rotary blower packages: BBC - HBC series	14-15
Super-class blowers: HB - PI series	16-17
SIGMA CONTROL 2 controller.....	18-19
Complete solutions from the systems provider.....	20-21
Advanced manufacture.....	22-23
Special versions	24-25
Accessories	26-27
Technical specifications.....	28-29

Fields of application



Efficient and oil-free gas transportation, pneumatic conveying, drinking and wastewater treatment (filter cleaning and clarifier aeration), liquid homogenisation and forced air systems for combustion equipment; the possibilities are almost endless – KAESER blowers are as versatile and varied as the applications that they are used for.

How a KAESER rotary blower works

The pressure build-up process – the images show a cross-sectional view through the flow chamber of the KAESER OMEGA rotary blower block.

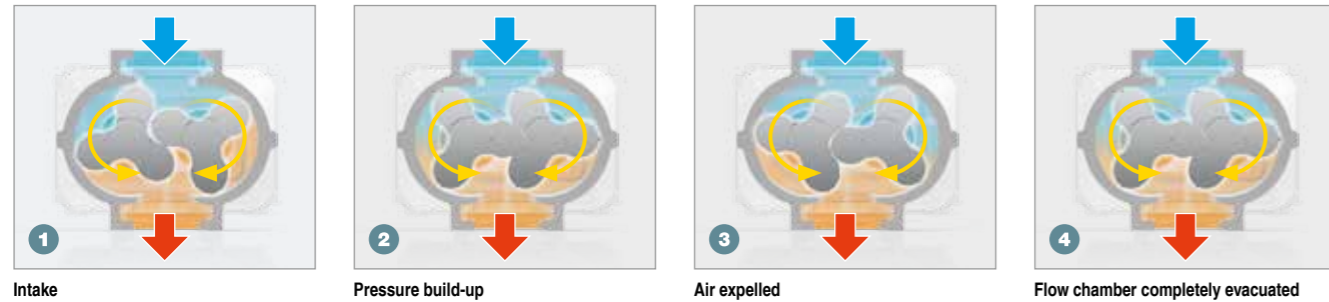

Oil-free, isochoric compression process

As the intake air passes through the rotary blower's flow chamber, its volume remains constant (isochoric process). Actual compression takes place outside of the blower block with the accumulation of the air mass taking place in the subsequent process.

This "adaptive" compression always produces only the amount of pressure needed by the process. This makes rotary blowers particularly suitable for applications with a relatively high proportion of idling (e. g. pneumatic conveying) and/or heavily fluctuating pressure.

The numbers correspond to the points in the pressure-volume diagram.

- 1) Intake and capture of atmospheric air (left rotor).
- 2) Air is conveyed towards the pressure side; compression commences at the 120° rotation angle due to prior influx of already compressed air.
- 3) Compression in the flow chamber ceases; discharge commences.
- 4) Conveyed air mass is discharged into the process.

How a KAESER screw blower works

The pressure build-up process – the images show cross-sections of the enclosed volume in the KAESER SIGMA-B screw blower airend, with a view from the pressure side of the rotor pair.

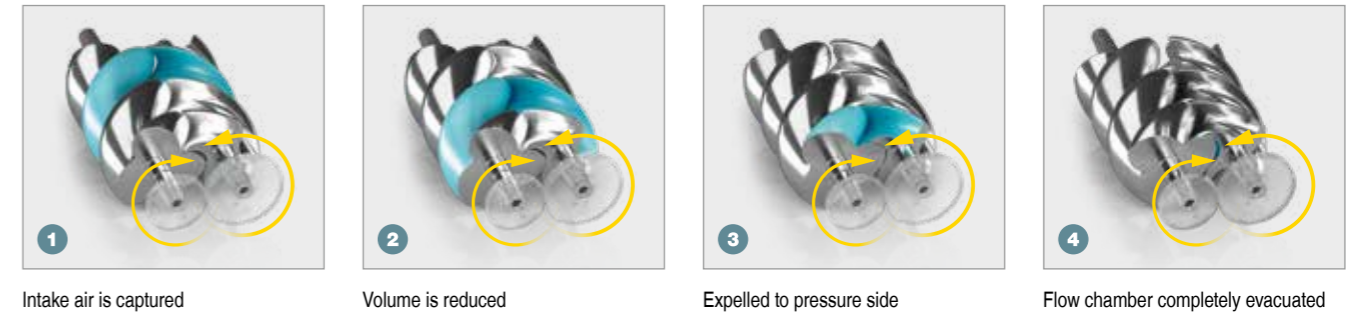

Oil-free, isentropic compression process

As the intake air passes through the screw blower's flow chamber, its volume remains largely constant (isentropic process). Actual compression takes place inside of the airend: the volume of air is continuously reduced until discharge and pushed out under pressure – because less effort is required for compression of the same air volume, energy consumption is lower. Screw blowers are the ideal solution for applications with more or less constant pressure and high running performance requirements, such as aeration of wastewater treatment plants, flotation, etc.

The numbers correspond to the points in the pressure-volume diagram.

- 1) Intake and capture of atmospheric air.
- 2) Air conveyed towards the pressure side for discharge.
- 3) Pressure increases due to volume reduction.
- 4) Compressed air is expelled.

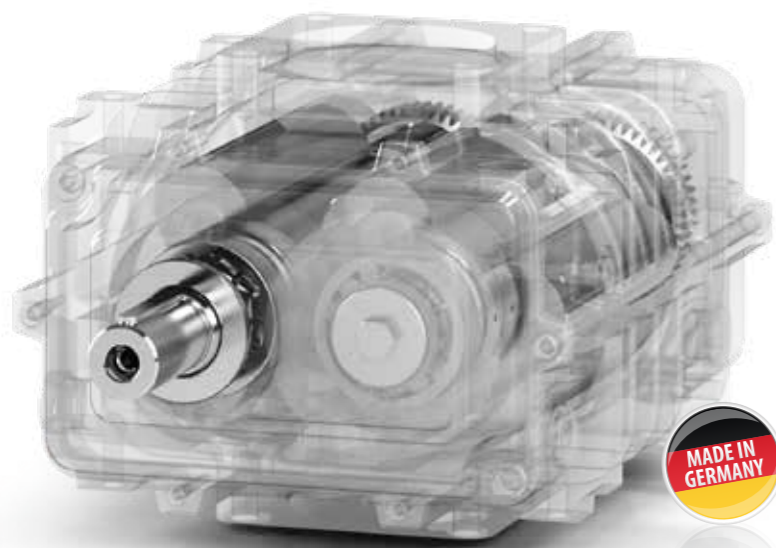
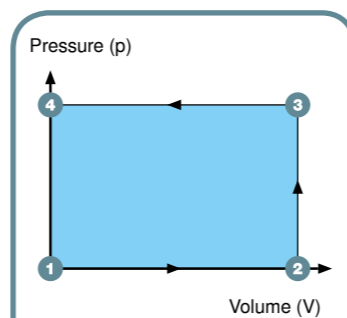

Image: OMEGA block

OMEGA



The pressure-volume diagram (P-V diagram) illustrates the compression work in proportion to the energy expended on the basis of the area depicted in blue between points 1 to 4.



Image: SIGMA blower airend

SIGMA

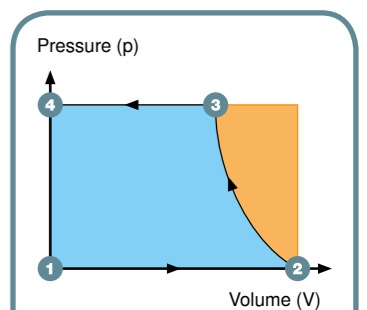

The pressure-volume diagram (P-V diagram) illustrates the energy, or compression work, expended for compression on the basis of the area depicted in blue between points 1 to 4.

The orange area shows the potential energy savings when a screw blower is used in comparison to a conventional rotary blower (roots blower), as long as no over-compression occurs.



Screw blowers – pure efficiency with the SIGMA PROFILE

Developed in the company's in-house Research and Development centre, KAESER screw blower airends with world-renowned SIGMA PROFILE rotors are up to 35 percent more efficient than conventional designs.

This highly efficient blower airend features a wide control range and ensures virtually constant specific power.

In addition to efficiency, durability was also an essential development goal. The use of high-tech bearings and no need for ancillary equipment further minimises energy consumption and also enhances reliability.

Technical specifications:

DBS, EBS, FBS series

Usable flow rate:

4.5 to 67 m³/min

Differential pressure:

- Pressure up to 1100 mbar

- Vacuum to 550 mbar



DBS drive concept

In the DBS series, drive power transmission from the motor to the blower airend occurs with an integrated gear transmission. This has proven to be the best solution for the speeds in this performance and size class with regards to efficiency, reliability and durability.



Belt drive – refined to perfection

The pivoting motor base with tensioning spring ensures precision belt tensioning, irrespective of motor weight, to provide optimum transmission efficiency at all times. As a result of KAESER's decades of experience in compressor design and engineering, this power transmission approach has been refined to perfection.



Dependable seals

KAESER's long-proven sliding ring seal on the rotary transmission drive shaft lead-through of the screw blower block is maintenance-free and provides dependable sealing, even in hot and/or dusty environments.



Durable bearings

All radial gas forces are completely absorbed by four heavy-duty cylinder roller bearings to ensure maximum airend service life. The rollers are encased in high-tech cages for optimum lubrication at all speeds. No additional oil pressure lubrication is required.

Screw blowers – DBS, EBS, FBS series SFC / STC version

Delivered as user-friendly, turnkey systems, KAESER screw blowers simply need to be connected to the air distribution network and the electrical supply and you're ready to go! The laborious processes of oil-filling, drive belt installation, motor adjustment, procurement of a suitable frequency converter, programming, cabling in accordance with EMC regulations, drawing circuit diagrams, organising CE and EMC certification are thankfully things of the past.

There's no doubt about it: complete, certified machines from systems providers save time and money while delivering many years of dependable operation.

SFC version: Variable speed with frequency converter

STC version: With Y-Δ-Starter



SIGMA CONTROL 2 controller

The SIGMA CONTROL 2 ensures efficient blower control and system monitoring. Various interfaces enable rapid communication with control centres via data bus, whilst the SD card slot makes data storage and updates a breeze. Various operating modes are selectable on SFC/OFC machines.



Seamless system monitoring

Sensors for oil level and temperature monitoring are integrated into the blower air end. The oil chamber is designed to ensure dependable oil level measurement in all operating phases.

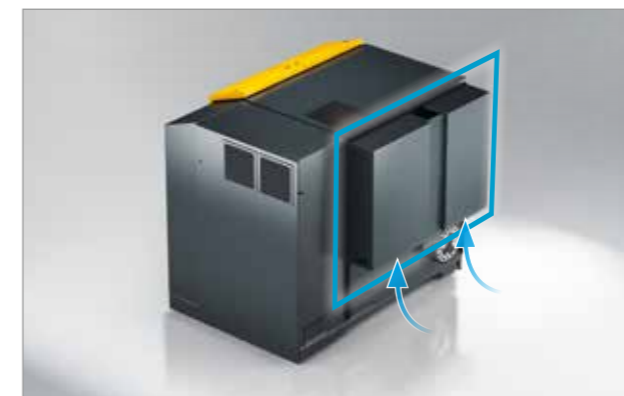

Cool inlet air

Process air and cooling air for the motor are drawn in separately from outside of the enclosure. This boosts efficiency and leads to a higher usable air mass flow rate for the same power consumption. The blowers can operate at full capacity at ambient temperatures up to +45 °C.



Optimised specific power

The moderate maximum speed, the extra dense screw profile and the near constant specific power across the wide variable speed control range all combine to achieve significant energy savings throughout the entire operating curve.

Rotary blowers – air at the touch of a button

The special OMEGA Profile in KAESER's three-lobe rotary blowers makes these machines true masters of efficiency. The long-term dependability and durability of these units is legendary.

This is attributed to design features such as the use of straight-cut timing gears, heavy-duty cylinder roller bearings and precisely balanced rotors.

Technical specifications:

Usable flow rate:
1.5 to 72 m³/min

Differential pressure:
- Pressure up to 1000 mbar
- Vacuum to 500 mbar

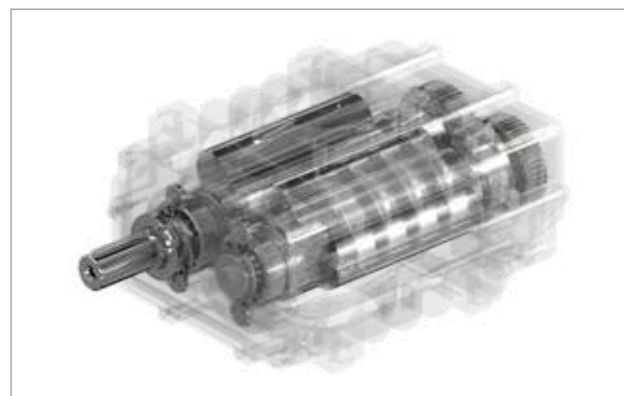

Durable OMEGA blower block

The OMEGA blower block delivers pressures up to 1000 mbar(g), discharge temperatures up to 160 °C, wide control range with frequency-controlled operation, Q 2.5 rotor balancing for quieter operation, extended service life and minimal maintenance requirement.



Durable bearings

Heavy-duty cylinder roller bearings completely absorb the continuously changing radial gas-forces. As a result, they avoid the springing effect of self-aligning bearings and last up to ten times longer with the same loading.



Precision manufacture/synchronisation

KAESER blower blocks feature high-precision 5f 21 quality straight-cut timing gears with minimal flank clearance, which play a major role in contributing to the block's outstanding volumetric efficiency. Since the straight-cut gearing is not subjected to continuously changing axial gas-forces, heavy-duty cylinder roller bearings can be used.



Stable rotors

The extremely high-quality Q 2.5 rotor balancing, combined with the rotor's single-piece design, including the shaft ends, ensures low-vibration and quiet operation. Rotor tips with integrated sealing strips make the blower block more resistant to dust particulate and thermal stress.

Complete turnkey rotary blowers BB-FB series, OFC/STC version

KAESER's COMPACT series turnkey rotary blowers with OMEGA PROFILE rotors provide more than dependable, energy-efficient performance. Delivered ready for immediate operation, these versatile units are equipped with star-delta starter (or frequency converter) and all necessary sensors are CE and EMC certified. As a result, they save considerable costs associated with planning, installation, certification, documentation and commissioning.



START CONTROL (STC)

The version with integrated Y- Δ -starter operates at constant speed and is equipped with a premium contactor, overload protection cut-out and phase monitoring. The SIGMA CONTROL 2 and a dependable emergency stop system round out the package.



Frequency control (OFC)

With OMEGA FREQUENCY CONTROL, the frequency converter adjusts blower performance to match required air demand by regulating the motor speed. Everything is ready for immediate operation, since all programming and parametrisation is performed at the factory.



Plug-and-play

The turnkey blowers not only come complete with sensors, STC/OFC, SIGMA CONTROL 2 and emergency stop switch, but are also ready-filled with oil and are fully certified. This significantly reduces the work and costs required for planning, installation, certification, documentation and commissioning.



EMC tested and certified complete system

To ensure seamless integration into any operational environment, the electromagnetic compatibility (EMC) of all components and of the complete machine has been tested and certified in accordance with all applicable regulations





BB - HB series

Usable flow rate:
0.59 to 93 m³/min

Differential pressure:
- Pressure up to 1000 mbar
- Vacuum to 500 mbar



Rotary blower packages for system integration

Efficient, quiet, durable and versatile – whether used to convey bulk materials or as heeling dampers on a container ship: KAESER blower packages are renowned throughout the world for their impressive performance no matter what the application. No wonder they're so highly valued by users everywhere!



IE3 energy-saving motors

All KAESER blower packages are equipped with dependable, premium efficiency IE3 drive motors (IP55 protection, Insulation Class F). Their exceptional efficiency boosts overall system performance.



Sensors

Various sensors and switches for monitoring pressure values, temperatures, speed, oil level and filters ensure dependable and efficient blower operation and enable remote system monitoring.

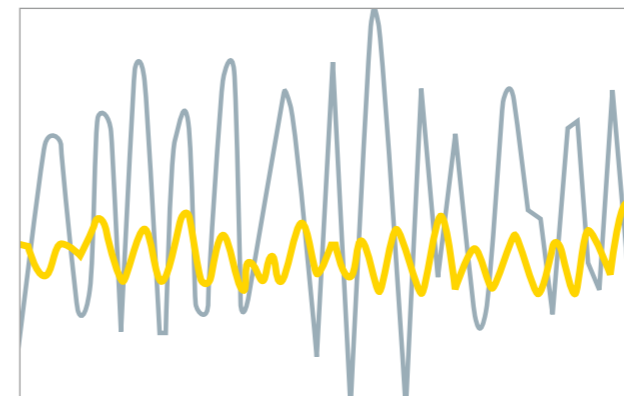

Minimal pulsation and quiet operation

As pulsations from the conveying air can cause the connected pipework to generate noise, the soundproofing on KAESER blowers is designed to minimise sound emissions from both the machine itself and from the conveying air. Moreover, highly effective discharge silencers cover a wide frequency range to mitigate conveying air pulsation.



Automatic belt tensioning

The pivoting motor base with tensioning spring ensures precision belt tensioning, irrespective of motor weight, to provide optimum transmission efficiency at all times. Consequently, this system also reduces maintenance and energy costs.

Super-class blowers

HB-PI series – large and versatile

KAESER's HB-PI series rotary blowers are the perfect choice for applications that require large air delivery volumes and maximum availability, such as in large water treatment plants, or in power generation stations.

They are flexible, durable and dependable. Moreover, in combination with rapid-response KAESER Service, uninterrupted operation is guaranteed at all times.

Technical specifications:

HB-PI series

Usable flow rate:
55 to 160 m³/min

Differential pressure:
- Pressure up to 1000 mbar
- Vacuum to 500 mbar

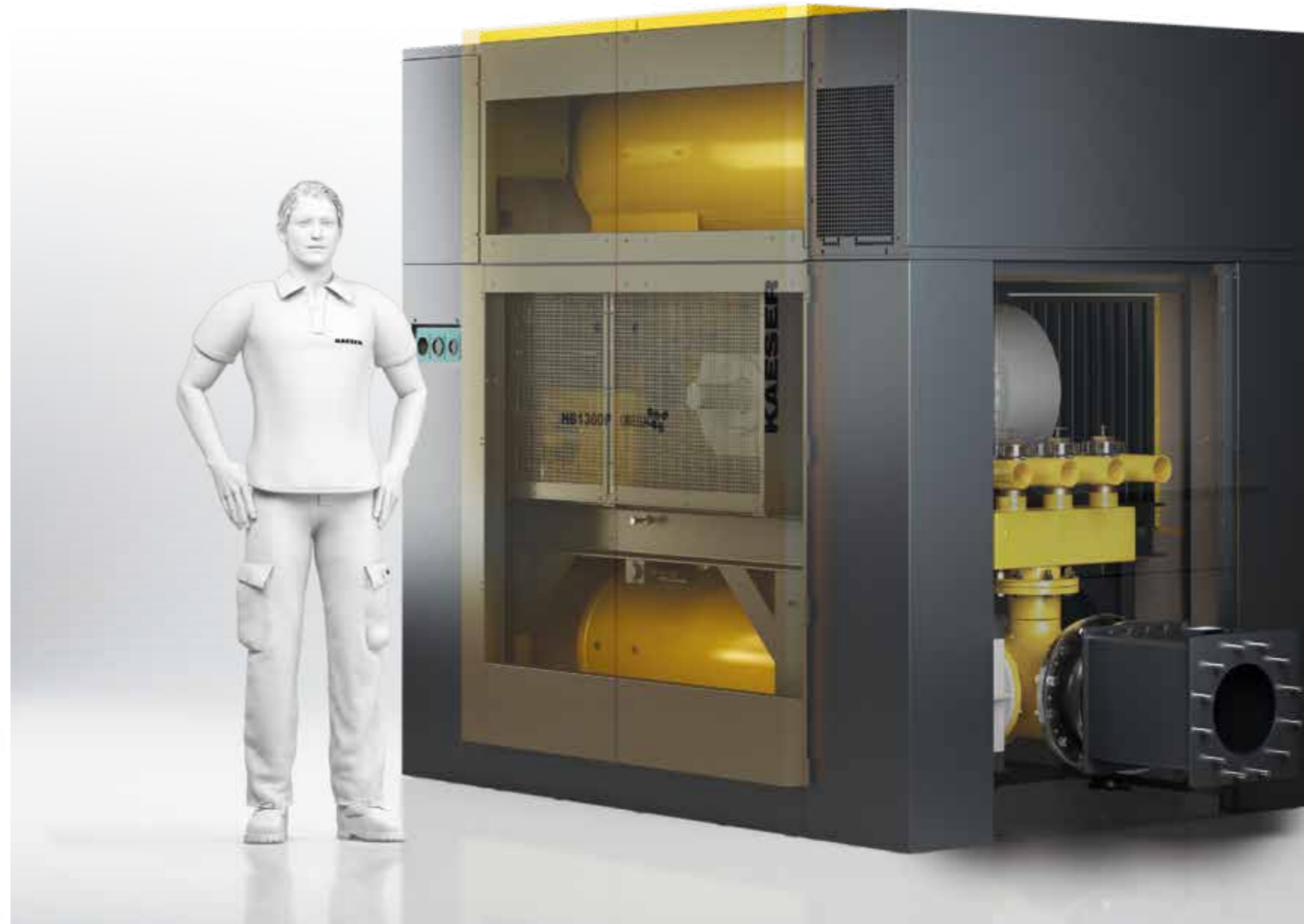

IE3 energy-saving motors

All KAESER blower packages are equipped with dependable, premium efficiency IE3 drive motors (IP55 protection, Insulation Class F). Medium-voltage motors can also be optionally used.



Frequency converter and Y-Δ starter

Special frequency converters and star-delta starters are also available for HB-PI series blowers. The OMEGA FREQUENCY CONTROL (OFC) enables infinite blower speed adjustment and, with the addition of a pressure sensor, also allows pressure regulation.



Dependable belt drive

The pivoted motor base and tensioning spring automatically ensure optimum belt tension and, as a result, optimal transmission efficiency. Consequently, this system also reduces wear whilst boosting dependability.



Clever cooling air flow

Outstanding cooling performance is assured, as the drive motor is equipped with its own cooling air intake and ambient air is used for the process air. This results in maximum efficiency even under high load.

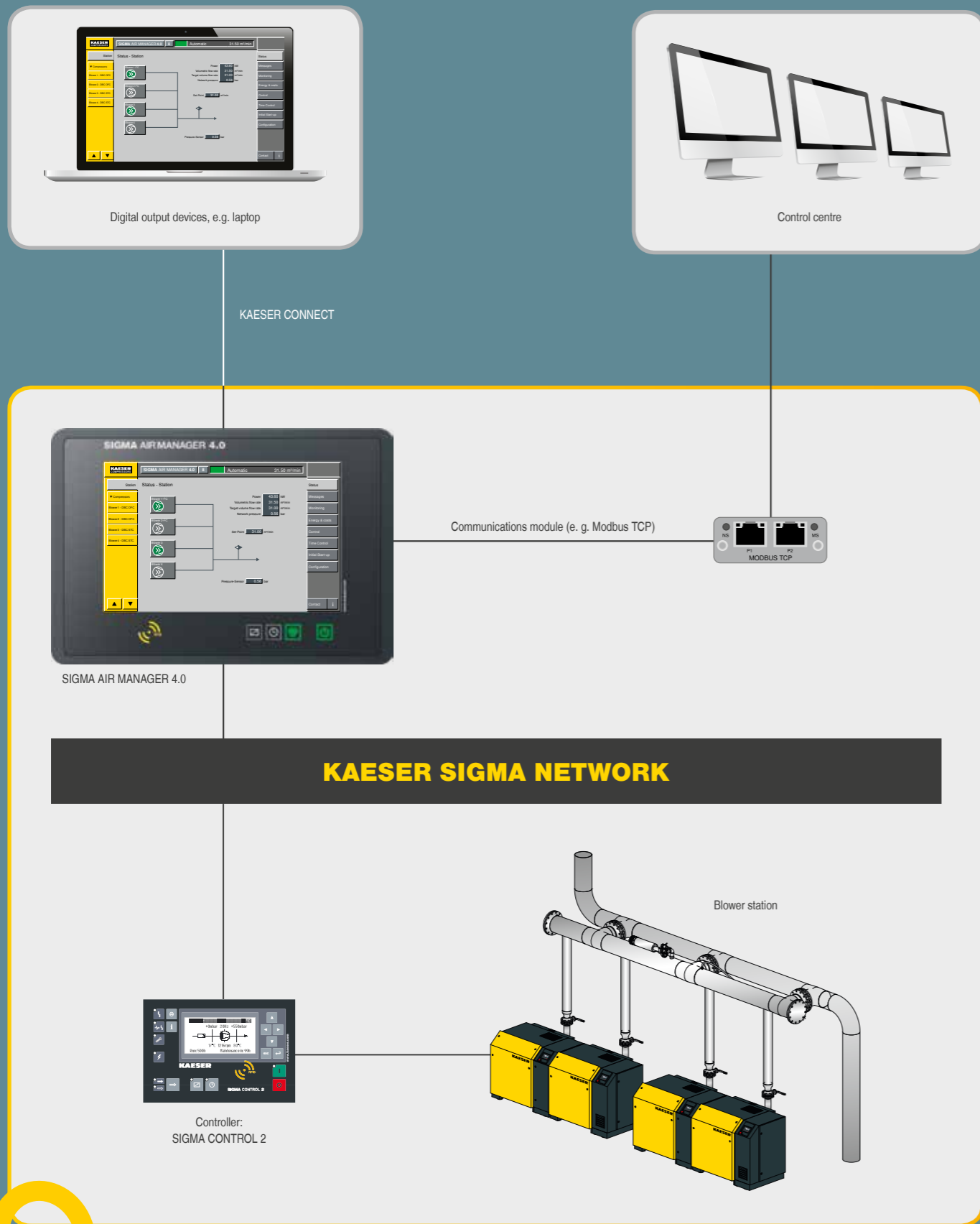

Industry 4.0 – Join the Network

With the SIGMA CONTROL 2 and SIGMA AIR MANAGER 4.0, all blower stations can be seamlessly integrated into Industry 4.0 environments to enable continuous system optimisation through analysis of operating data and to provide demand-oriented preventative maintenance and servicing (Predictive Maintenance) through remote diagnostics (Condition Monitoring).

Intelligence inside SIGMA CONTROL 2 blower controller

Using a range of sensors, the internal SIGMA CONTROL 2 blower controller monitors and controls all relevant machine and process parameters essential to reliable and efficient blower system operation. Available remote monitoring and control further enhance blower availability and efficiency.

Versatile communication modules also enable SIGMA CONTROL 2 equipped blower packages to connect to master control systems, such as the SIGMA AIR MANAGER, and / or other centralised control systems via data bus.



The control centre

The control centre features an easy to read display and durable input keys, whilst the clear menu structure, together with 30 selectable languages, enables universal operation. Various operating modes are selectable on SFC/OFC machines.



Stay connected

The Ethernet interface (10/100 Mbit/sec) allows users to call-up operational parameters on an Internet browser via the integrated web server. Optional communications modules: Modbus-RTU, Modbus/TCP, Profi bus DP-VO, Device-Net and Profi -Net IO.

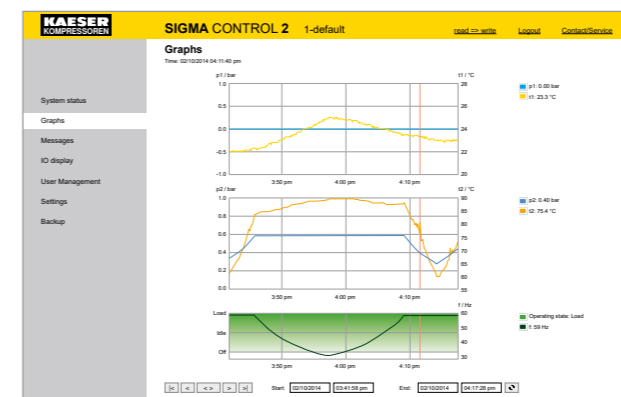

KAESER-CONNECT

Simply connect a PC and the SIGMA CONTROL 2 (SC2) with the LAN and input the SC2 address and password in the browser. Once this is done, machine status, operating data, alarm messages, as well as graphical representation of pressure, temperature and speed can be viewed in real time.



Update and save

Software updates and operational parameters can be quickly uploaded and transferred via the convenient SD card slot. Service costs are therefore kept to an absolute minimum. Key operational data can also be stored on the SD card.

One-stop shop Complete solutions from the systems provider

A business's blower air supply is far more than the sum of the necessary equipment and components, and by that token, as a comprehensive compressed air and blower air systems provider, KAESER KOMPRESSOREN provides far more than just machines. This includes detailed demand analysis and seamless integration of the blower station into the business environment, as well as life-long availability assurance through rapid-response KAESER AIR SERVICE.



Precise demand analysis (ADA 2)

Using precise Air Demand Analysis (ADA) and the KAESER Energy Saving System (KESS), KAESER's experts are able to plan and design a system that is specially tailored to meet all of your blower air requirements for maximum efficiency and availability.



Fast, worldwide service

Since even the highest quality machines require regular maintenance, KAESER AIR SERVICE, with its specially trained service technicians and advanced logistics systems, assures continuous blower air availability and reliable delivery of genuine KAESER spare parts throughout the world.

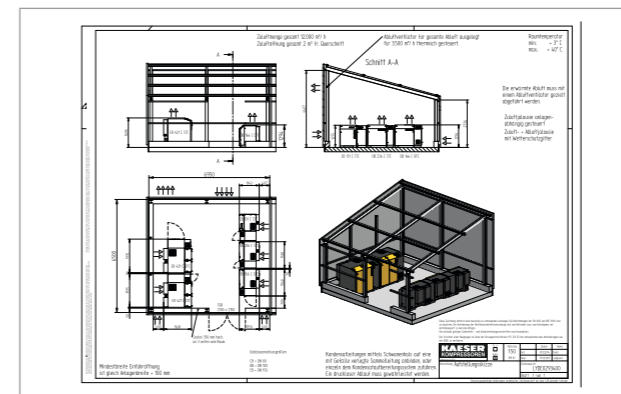

Detailed and expert planning

KAESER's experts meticulously plan and design a system that is tailored to meet the customer's specific blower air needs. Needless to say, this includes room ventilation and pipework, thereby ensuring peace of mind for users and project planners alike.



Optimum climate control

A holistic approach to the blower station also includes climate control. With expertise and components for optimum blower station climate control, KAESER blower systems always have the right amount of cool intake air available and therefore save energy through enhanced efficiency.



Advanced manufacture for quality and performance

The high level of vertical integration ensures exceptional quality of mechanical and electrical components and ensures seamless interplay between all individual parts and systems. All components are precisely matched with one another and are meticulously documented. This enables traceability and guarantees trouble-free spare parts supply at all times.



Rotor and block machining

All rotors and blocks are precision machined to micron accuracy, so that the resulting surface quality makes wear-susceptible coatings used for sealing superfluous.

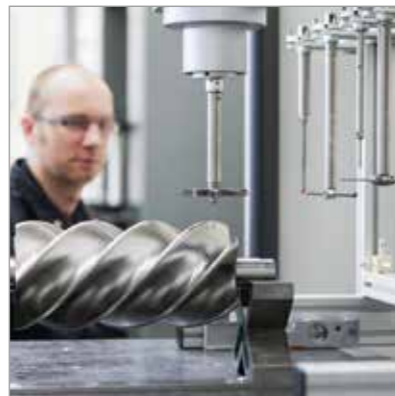

Measurement and inspection

To maintain the very best in product quality, we meticulously inspect and measure every block casing and rotor to ensure that it is manufactured to within the specified tolerances.



Powder coating

The enclosures receive their quality scratch and corrosion-resistant surface coating in an environmentally compatible 180 °C powder coating process.



Case manufacture

Just like the rotors, the casing for every KAESER rotary blower block is machined using advanced climate-controlled CNC machining centres to ensure consistently high product quality.



Final inspection

All adjustments, such as belt tensioning and alignment, are carried out ex-works prior to delivery. Moreover, every blower block is delivered ready-filled with oil and all valves are adjusted. All data are documented.



Flexible production

The very latest production techniques and processes at KAESER's Gera plant ensure exceptional product quality and enable customer-specific requirements to be met with minimal lead time.



Special versions for specialised applications

Whether used on a tanker lorry as a mobile unloading station, or for compression and / or conveying of media ranging from nitrogen to steam, KAESER blowers are truly dependable and efficient OEM components.



OMEGA B/PB – Corrosion resistant

Rotors and block casings are made from cast chromium-nickel alloy and with special internal block-sealing are available for processes such as the mechanical compression of water vapour in vacuum distillation for the concentration of aqueous media, for example.



WVC series – Fine vacuum

WVC series machines with a volumetric flow rate of up to 6,800 m³/hr are suited for fine vacuum applications such as in pumping stations with a booster pump to increase their volumetric flow rate.

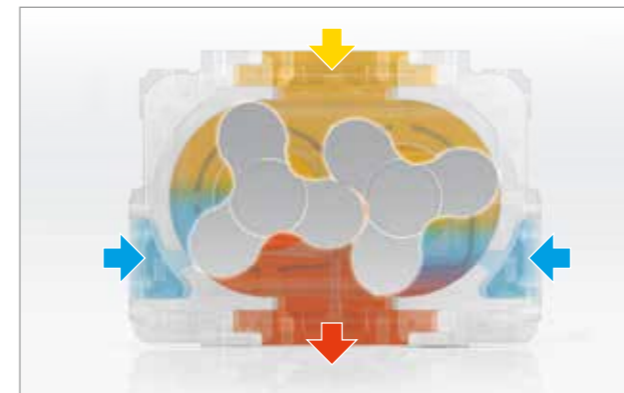

OMEGA PV – Low vacuum

With an intake capacity of up to 120 m³/min for low vacuum applications and a maximum of 900 mbar differential pressure, the OMEGA PV blower block is exceptionally robust, and is perfectly suited for use with silo vehicles. Block cooling is performed via atmospheric air flow through pre-inlet ducts.



OMEGA PN: Nitrogen conveying

These blowers are ideal for pneumatic conveying of bulk materials under nitrogen atmosphere conditions, where leakages of any kind need to be kept to an absolute minimum. PN series blowers are also available with wear-free slide ring sealing of the drive shaft rotary feed-through. Complete packages with OMEGA PN blocks are available for nitrogen conveying applications.

KAESER blower accessories for a wide range of applications

Many applications often require a specific air quality:

For example, some materials are sensitive to heat, whilst others may clump if humidity is too high. Another potential problem is contamination of the process air by particles contained in the ambient air.

As one of the world's leading and most experienced system providers, KAESER offers a wide range of coolers, dryers and filters for optimal matching of all air production and treatment components.

Furthermore, the SIGMA AIR MANAGER 4.0 enables the flow rate of every blower station to be specifically tailored to meet actual air demand, thereby ensuring maximum energy efficiency.



Co-ordination

Depending on the model, the SIGMA AIR MANAGER control system is able to co-ordinate operation of 4, 8 or 16 blowers within a blower installation and ensures even load distribution between the units.



Heat recovery

Easily integrated into process control systems, the heat exchanger enables exceptional process-air cooling even at high ambient temperatures. The hot water produced as a result of this process can be used for numerous purposes.



Cooling

At an ambient temperature of 20 °C, the highly efficient ACA type after-cooler is able to reduce blower air temperature to 30 °C without any additional effort.



Drying

KAESER's intake air desiccant dryers reduce the pressure dew point of process air with minimum differential pressure, thereby preventing condensate formation.



The operating environment

Carefully matched components, such as weather protection screens, fans, inlet / discharge silencers and appropriate air ducting, help to ensure and maintain optimum operating conditions in the machine room at all times.



Outdoor installation

COMPACT blowers are often installed outdoors in many wastewater treatment plants. These blower packages come equipped with rainproof stainless steel covers and premium powder-coated enclosures for effective protection against the elements.

Technical specifications

Screw blowers (EBS to FBS series, STC/SFC) – up to 110 kW, turnkey with integrated electrical system

Model	Gauge pressure			Vacuum			Pipe connection DN	Dimensions With control cabinet and sound enclosure W x D x H mm	Max. mass kg
	Max. differential pressure	Max. flow rate *	Max. rated motor power	Max. differential pressure	Max. flow rate *	Max. rated motor power			
	mbar (g)	m³/min	kW	mbar (vac)	m³/min	kW			
DBS 220 L SFC	650	23	30	–	–	–	100	1110 x 1480 x 1670	820
DBS 220 M SFC	1100	22	37	550	22	30	100	1110 x 1480 x 1670	850
DBS 220 L STC	650	19	22	–	–	–	100	1110 x 1480 x 1670	800
DBS 220 M STC	1100	18	37	–	–	–	100	1110 x 1480 x 1670	850
EBS 380 L SFC	650	38	45	–	–	–	150	1940 x 1600 x 1700	1400
EBS 380 M SFC	1100	37	75	550	37	37	150	1940 x 1600 x 1700	1600
EBS 380 L STC	650	36.5	45	–	–	–	150	1940 x 1600 x 1700	1400
EBS 380 M STC	1100	36	75	–	–	–	150	1940 x 1600 x 1700	1600
FBS 660 L SFC	650	67	75	–	–	–	200	2250 x 1950 x 1900	1850
FBS 660 M SFC	1100	66	110	550	63	75	200	2250 x 1950 x 1900	2200
FBS 660 L STC	650	66	75	–	–	–	200	2250 x 1950 x 1900	1850
FBS 660 M STC	1100	65	110	–	–	–	200	2250 x 1950 x 1900	2200

*) Performance specifications as per ISO 1217 Annex C for STC version, Annex E for SFC version

Compact blowers (BBC to FBC series, STC/SFC) – up to 132 kW, turnkey with integrated electrical system

Model	Gauge pressure		Vacuum		Max. rated motor power kW	Pipe connection DN	Dimensions With control cabinet and sound enclosure W x D x H mm	Max. mass kg
	Max. differential pressure	Max. flow rate *	Max. differential pressure	Max. flow rate *				
	mbar (g)	m³/min	mbar (vac)	m³/min				
BB 69 C	1000	5.9	500	5.9	15	65	1210 x 960 x 1200	455
BB 89 C	1000	8.2	500	5.9	15	65	1210 x 960 x 1200	461
CB 111 C	800	8.8	400	8.9	18.5	80	1530 x 1150 x 1290	583
CB 131 C	1000	12.3	500	12.4	30	80	1530 x 1150 x 1290	642
DB 166 C	1000	15.6	500	15.7	37	100	1530 x 1150 x 1290	802
DB 236 C	1000	22.1	500	22.3	45	100	1530 x 1150 x 1290	822
EB 291 C	1000	28.6	500	28.8	75	150	1935 x 1600 x 1700	1561
EB 421 C	1000	40.1	500	40.4	75	150	1935 x 1600 x 1700	1606
FB 441 C	1000	41.3	500	41.6	90	200	2230 x 1920 x 1910	2326
FB 621 C	1000	58.5	500	58.9	132	200	2230 x 1920 x 1910	2839
FB 791 C	800	71.3	500	71.8	110	250	2230 x 1920 x 2090	2541

*) Performance specifications as per ISO 1217 Annex C for STC version, Annex E for SFC version

Blower packages (BBC to HBPI series) – up to 250 kW

Model	Gauge pressure		Vacuum		Max. rated motor power kW	Pipe connection DN	Dimensions Without sound enclosure W x D x H mm	Max. mass kg	Dimensions With sound enclosure W x D x H mm	Max. mass kg
	Max. differential pressure	Max. flow rate *	Max. differential pressure	Max. flow rate *						
	mbar (g)	m³/min	mbar (vac)	m³/min						
BB 52 C	1000	4.7	500	4.7	7.5	50	785 x 635 x 940	140	800 x 790 x 1120	210
BB 69 C	1000	5.9	500	5.9	11	65	890 x 660 x 960	195	800 x 790 x 1120	325
BB 89 C	1000	8.2	500	8.3	15	65	890 x 660 x 960	201	800 x 790 x 1120	331
CB 111 C	800	8.8	400	8.9	18	80	855 x 1010 x 1290	263	990 x 1160 x 1290	443
CB 131 C	1000	12.3	500	12.4	30	80	855 x 1010 x 1290	302	990 x 1160 x 1290	482
DB 166 C	1000	15.6	500	15.7	37	100	990 x 1070 x 1120	432	1110 x 1160 x 1290	632
DB 236 C	1000	21.1	500	22.3	45	100	990 x 1070 x 1120	482	1110 x 1160 x 1290	682
EB 291 C	1000	28.6	500	28.8	75	150	1240 x 1370 x 1510	921	1420 x 1600 x 1659	1261
EB 421 C	1000	40.1		40.4	75	150	1240 x 1370 x 1510	966	1420 x 1600 x 1659	1306
FB 441 C	1000	41.3	500	41.6	90	200	1790 x 1450 x 1750	1450	1920 x 1620 x 1910	1960
FB 621 C	1000	58.5	500	58.9	132	200	1790 x 1450 x 1750	1865	1920 x 1620 x 1910	2375
FB 791 C	800	71.3	450	71.8	110	250	1870 x 1450 x 1900	1717	1920 x 1620 x 2090	2247
HB 950 C	1000	93.1	500	91.65	200	250	1700 x 1700 x 1950	3005	2170 x 1864 x 2110	3805
HB 1300 PI	1000	125	500	122.93	250	300	2710 x 1600 x 2350	3465	3205 x 2150 x 2610	4285
HB 1600 PI	800	156	450	153.27	250	300	2710 x 1600 x 2350	3625	3205 x 2150 x 2610	4445

*) Performance specifications as per ISO 1217 Annex C



Guaranteed performance specifications

To ensure that you benefit from the projected savings during actual operation, KAESER provides you with the effective overall power consumption data as well as the usable flow rate in accordance with the stringent tolerances of ISO 1217, Appendix C, or E as applicable.



OMEGA

KAESER

STC AA

EBS 380L SIGMA

KAESER

SFC

EBS 380L SIGMA

KAESER

STC AA

EBS 380L SIGMA

KAESER

The world is our home

As one of the world's largest compressed air system providers and compressor manufacturers, KAESER KOMPRESSOREN is represented throughout the world by a comprehensive network of branches, subsidiary companies and authorised partners in over 140 countries.

With innovative products and services, KAESER KOMPRESSOREN's experienced consultants and engineers help customers to enhance their competitive edge by working in close partnership to develop progressive system concepts that continuously push the boundaries of performance and compressed air efficiency.

Moreover, the decades of knowledge and expertise from this industry-leading system provider are made available to each and every customer via the KAESER group's global computer network.

These advantages, coupled with KAESER's worldwide service organisation, ensure that every product operates at the peak of its performance at all times and provides maximum availability.



HPC | Compressed
Air Systems

HPC Compressed Air Systems, Victoria Gardens, Burgess Hill, West Sussex RH15 9RQ
Tel: 01444 241671 Fax: 01444 247304 E-Mail: info@hpcplc.co.uk www.hpccompressors.co.uk